

# Inverter Air Source Water Heat Pump

---

Floor heating and Air-con Unit

**Installation and Instruction Manual**



**LMNT.**

For outdoor installation only







# CONTENT

1	Preface	1
2	Safety Precaution	2
	(1) Mark notes	2
	(2) Icon Notes	2
	(3) Warning	3
	(4) Attention	4
3	Specification	5
	(1) Appearance and structure of the heat pump	5
	(2) The data of unit	5
	(3) Unit dimension	6
4	Installation	8
	(1) Application of heat pump	8
	(2) Choose a right heat pump unit	9
	(3) Installation method	9
	(4) Installation place	10
	(5) Refrigerant charge	10
	(6) Water loop connection	11
	(7) Power supply connection	11
	(8) Location of the unit	11
	(9) Transit	12
	(10) Trial Running	12
5	<b>Operation and Use</b>	13
	(1) Main interface display and function	13
	(2) Setting interface display and function	22
	(3) Status interface display	36
	(4) Parameter list and breakdown table	37
	(5) Interface diagram	40
6	Appendix	44
	(1) Appendix 1	44
	(2) Appendix 2	45
	(3) Appendix 3	46

# Preface

---

- In order to provide the customers with high quality, strong reliability and good versatility product, this heat pump is produced by strict design and manufacture standards.

This manual includes all the necessary information about installation, debugging, discharging and maintenance. Please read this manual carefully before you open or maintain the unit.

The manufacture of this product will not be held responsible if someone is injured or the unit is damaged, as a result of improper installation, debugging, unnecessary maintenance which is not in line with this manual.

The unit must be installed by qualified personnel.

- It is vital that the below instructions are adhered to at all times to keep the warranty.

—The unit can only be opened or repaired by qualified installer or an authorised dealer.

—Maintenance and operation must be carried out according to the recommended time and frequency, as stated in this manual.

—Use genuine standard spare parts only.

Failure to comply with these recommendations will invalidate the warranty.

- Inverter air source water heat pump is a kind of high efficiency, energy saving and environment friendly equipment, which is mainly used for house warming. It can work with any kind of indoor unit such fan coil, radiator, or floor heating pipe, by provide warm or hot water. One unit of monobloc heat pump can also work with several indoor units. The air source water heat pump unit is designed to have heat recovery by using super heater which can provide hot water for sanitary purpose.

This series of heat pump unit owns following features:

## 1 Advanced controlling

The PC microcomputer based controller is available for the users to review or set the running parameters of the heat pump. Centralized controlling system can control several units by PC.

## 2 Nice appearance

The heat pump is designed with beautiful looking. The monobloc one has the water pump included which is very easy for installation.

## 3 Flexible installation

The unit has smart structure with compact body, just simple outdoor installation is needed.

## 4 Quiet running

High quality and efficient compressor, fan and water pump is used to ensure the low noise level with insulation.

## 5 Good heat exchange rate

The heat pump unit use special designed heat exchanger to enhance whole efficiency.

## 6 Large working range



This series of heat pump is designed to work under different working conditions as low as -15 degrees for heating.

# Safety Precaution



---

To prevent the users and others from the harm of this unit, and avoid damage on the unit or other property, and use the heat pump properly, please read this manual carefully and understand the following information correctly.

## Mark Notes



Mark	Meaning
 WARNING	A wrong operation may lead to death or heavy injury on people.
 ATTENTION	A wrong operation may lead to harm on people or loss of material.



## Icon notes



Icon	Meaning
	Prohibition. What is prohibited will be nearby this icon
	Compulsory implement. The listed action need to be taken.
	<b>ATTENTION</b> (include <b>WARNING</b> ) Please pay attention to what is indicated.

# Safety Precaution

## Warning

Installation	Meaning
 Professional installer is required.	The heat pump must be installed by qualified personals, to avoid improper installation which can lead to water leakage, electrical shock or fire.
 Earthing is required	Please make sure that the unit and power connection have good earthing, otherwise may cause electrical shock.

Operation	Meaning
 PROHIBITION	DO NOT put fingers or others into the fans and evaporator of the unit, otherwise harm may be occurred.
 Shut off the power	When there is something wrong or strange smell, the power supply need to be shut off to stop the unit. Continue to run may cause electrical short or fire.

Move and repair	Meaning
 Entrust	When the heat pump need to be moved or installed again, please entrust dealer or qualified person to carry it out. Improper installation will lead to water leakage, electrical shock, injury or fire.
 Entrust	It is prohibited to repair the unit by the user himself, otherwise electrical shock or fire may be occur.
 Prohibit	When the heat pump need to be repaired, please entrust dealer or qualified person to carry it out. Improper movement or repair on the unit will lead to water leakage, electrical shock, injury or fire.





Do not use means to accelerate the defrosting process or to clean, Other than those recommended by the manufacturer.





The appliance shall be stored in a room and install in the environment without continuously operating or potential ignition sources (for example: open flames, an operating gas appliance or an operating electric heater or Electric Spark or hot object)

# Safety Precaution

---

## ATTENTION

Installation	Meaning
 Installation Place	The unit CANNOT be installed near the flammable gas. Once there is any leakage of the gas, fire can occur.
 Fix the unit	Make sure that the basement of the heat pump is strong enough, to avoid any decline or fall down of the unit
 Need circuit breaker	Make sure that there is circuit breaker for the unit, lack of circuit breaker can lead to electrical shock or fire.

Operation	Meaning
 Check the installation basement	Please check the installation basement in a period (one month), to avoid any decline or damage on the basement, which may hurt people or damage the unit
 Switch off the power	Please switch off the power for clean or maintenance.
 Prohibition	It is prohibited to use copper or iron as fuse. The right fuse must be fixed by electrician for the heat pump.
 Prohibition	It is prohibited to spray the flammable gas to the heat pump, as it may cause fire.

# Specification

## 1. Appearance and structure of the heat pump

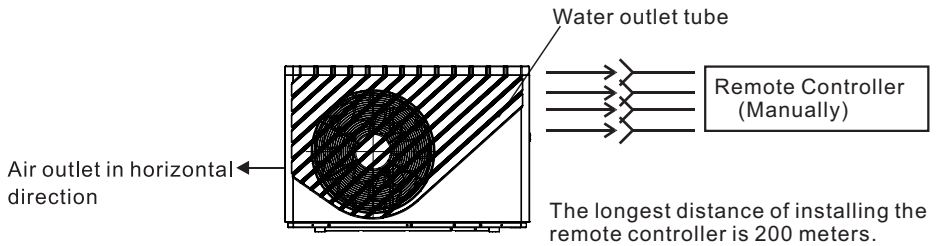

## 2. The data of unit

\*\*\* REFRIGERANT : R290

Model		CASWR020B-S	CASWR040B-T	CASWR060B-T
Heating Capacity	kW	3.10~8.90	5.40~14.95	8.00~22.00
Heating Power Input	kW	0.65~2.10	1.05~3.85	1.60~6.90
Cooling Capacity	kW	1.20~5.72	3.60~10.50	4.20~15.00
Cooling Power Input	kW	0.65~2.40	1.12~4.47	1.80~7.30
Hot Water Capacity	kW	3.92~10.68	6.50~18.50	10.00~27.00
Hot Water Power Input	KW	0.78~2.47	1.27~4.65	1.90~7.10
Max Power Input	KW	3.0	5.30	8.3
Max Current Input	A	13.5	10.5	15.0
Power Supply		220~240V~/50Hz	380~415V/3N~/50Hz	380~415V/3N~/50Hz
Compressor Quantity		1	1	1
Compressor Model		Rotary	Rotary	Rotary
Fan Quantity		1	1	2
Fan Power Input	W	150	170	75
Fan Rotate Speed	RPM	600	600	600
Water Pump Input	W	60	60	160
Noise	dB(A)	38~52	39~52	42~54
Water Connection	inch	1	1	1
Water Flow Volume	m <sup>3</sup> /h	1.0	1.7	2.9
Internal Water Pressure Drop	kPa	20	30	45
Water Head	m	5.0	5.5	6.9
Unit Net Dimensions (L/W/H)	mm	See drawings of the heat pump		
Unit Shipping Dimensions (L/W/H)	mm	see data on the package		
Net Weight	kg	see data on the nameplate		
Shipping Weight	kg	see data on the package		

Cooling working condition:(DB/WB)35°C/24°C, (Outlet/Inlet) 7°C/12°C.

Heating working condition:(DB/WB) 7°C/6°C. (Outlet/Inlet) 35°C/30°C.

Hot Water working condition:(DB/WB): 20°C/15°C,water tank temperature circulation form 15°C to 55°C。

BS EN 14511-1-2013 Airconditioner, wholeliquid cooling machine,electric compressor.

Part2: Test condition ; Part3:Testmethod ; Part4:related requirements.

# Specification

## 3. Unit dimension

Models: CASWR020B-S

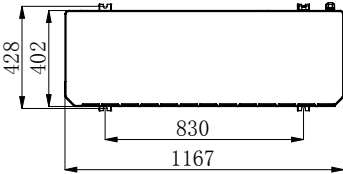
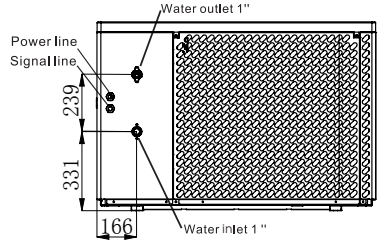
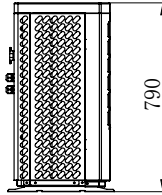
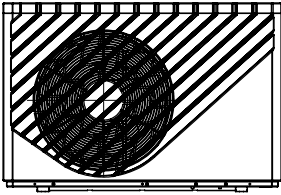

Models: CASWR040B-T

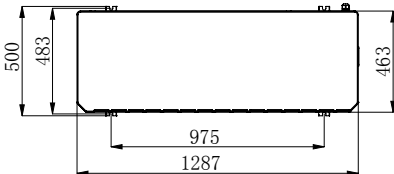
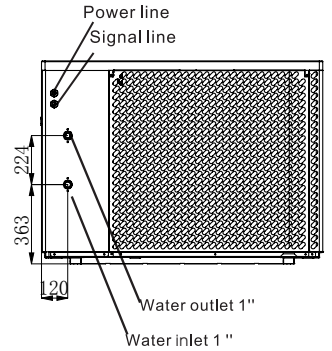
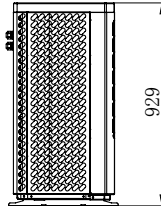
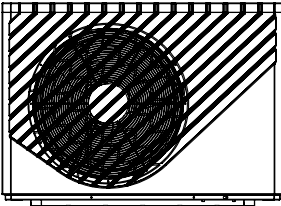

# Specification

Models: CASWR060B-T

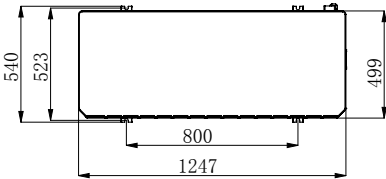
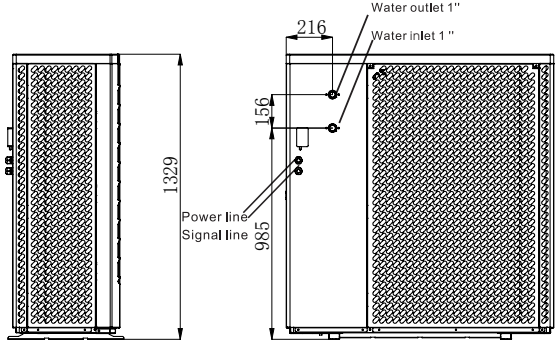
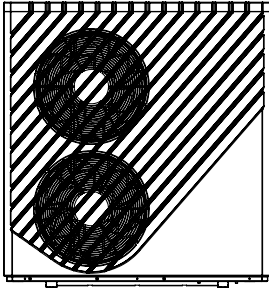



# Installation

## Unit features

1. Plate heat exchanger  
Use the SWEP efficient heat exchanger with small size and high efficiency.
- 2.Environmentally friendly refrigerant  
Use the new generation of environmentally friendly refrigerant R290, which is harmless to the ozone sphere.
3. Heating in frigid environment.  
Optimized designed unit can achieve the heating function normally even when the ambient temperature is  $-25^{\circ}\text{C}$ .
4. Infusing refrigerant  
The Heat Pump are lack of refrigerant and full of High-pressure nitrogen instead when Ex-factory . Before operating ,remember follow Operation Manual infusing therefrigerant .
5. Installation Environment  
The refrigerant R290 are flammable and explosive ,It's prohibit install in one environment which have operating or potential ignition sources .

## 1 Application of heat pump

### 1.1 House Heating/Cooling + Domestic Hot Water

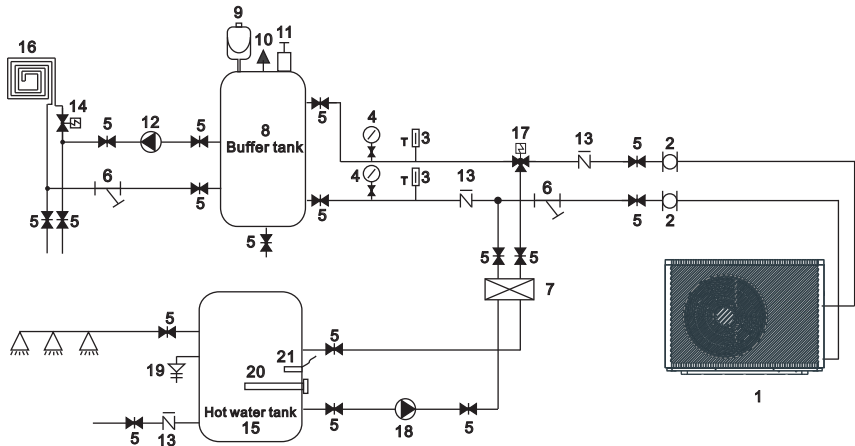

1	Heat pump	10	Relief valve	19	PT valve
2	Flexible pipe	11	Air vent valve	20	Electrical heater
3	Thermometer	12	Water pump for floor heating	21	Hot water sensor
4	Manometer	13	Check valve		
5	Shut-off valve	14	Floor heating valve		
6	Y type water filter	15	Hot water tank		
7	Plate heat exchanger	16	Floor heating pipe/fan coil unit		
8	Buffer tank	17	Hot water valve		
9	Expansion tank	18	Hot water pump		

Remark:Item 17, 18, 20, 21 can be connected with heat pump.

# Installation

## 1.2 House Heating/Cooling (includes Buffer tank)

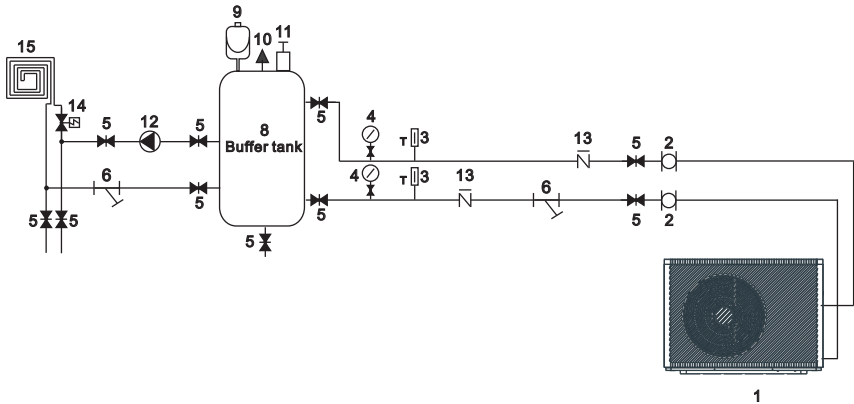

1	Heat pump	7	Plate heat exchanger	13	Check valve
2	Flexible pipe	8	Buffer tank	14	Floor heating valve
3	Thermometer	9	Expansion tank	15	Floor heating pipe/fan coil unit
4	Manometer	10	Relief valve		
5	Shut-off valve	11	Air vent valve		
6	Y type water filter	12	Water pump for floor heating		

## 2 Choose a right heat pump unit

- 2.1 Based on the local climate condition, construction features and insulation level, calculate the required cooling(heating) capacity per square meter.
- 2.2 Conclude the total capacity which will be needed by the construction.
- 2.3 According to the total capacity needed, choose the right model by consulting the heat pump features as below:

Heat pump features

- Cooling only unit: chilled water outlet temp. at 5-15°C, maximum ambient temp. at 43°C.
- Heating and Cooling unit: for cooling chilled water outlet temp. at 5-15°C, maximum ambient temp. at 43°C. For heating, warm water inlet temp. at 40-50°C, minimum ambient temp. at -25°C.
- Unit application  
Inverter air source water heat pump is used for house, office, hotel, and so forth, which need heating or cooling separately, with each area need to be controlled.

## 3 Installation method

The heat pump can be installed onto the concrete basement by expansion screws, or onto a steel frame with rubber feet which can be placed on the ground or housetop. Make sure that the unit is placed horizontally.

# Installation

## 4 Installation place

- The unit can be installed on any place outdoor which can carry heavy machine such as terrace, housetop, ground and so on.
- The location must have good ventilation.
- The place is free from heat radiation and other fire flame.
- A pall is needed in winter to protect the heat pump from snow.
- There must be not obstacles near the air inlet and outlet of the heat pump.
- A place which is free from strong air blowing.
- There must be water channel around the heat pump to drain the condensing water .
- There must be enough space around the unit for maintenance.
- A place which is far away operating or potential ignition sources (for example:open flames, an operating gas appliance or an operating electric heater or Electric Spark or hot object )

## 5 Refrigerant charge

The heat pump do not infusing the refrigerant 290 and full of high-pressure nitrogen or Keep it in a vacuum instead,please follow these steps to infusing refrigerant R290.

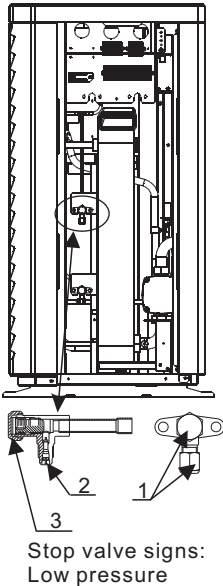

### 5.1 Preparations:

- 5.1.1 Please in a well-ventilated environment while charge refrigerant.
- 5.1.2 Keep away from open flames or potential sources of fire.
- 5.1.3 Disconnect the power supply of the heat pump.
- 5.1.4 Carefully check the nameplate of the heat pump and charge strictly according to the labeled amount.

5.2. Check the pressure of nitrogen gas inside the system. The heat pump has charged about 30 Bar pressure nitrogen gas inside the system, please check whether there is still high-pressure nitrogen before charging refrigerant, otherwise check the leakage point. (Use spanner remove the seal nut 1 and 3 , use 5mm inner hexagon spanner open the valve 2. If it can Blowing out the high-pressure gas then the heat pump is not leaking.)

- 5.3. Use 5mm inner hexagon spanner open the valve 2 and release all the nitrogen gas inside the system.
- 5.4. Vacuumize the heat pump. Connect the vacuume pump with the valve 2, keep vacuume pump running until the absolute pressure below 30Pa or operating time more than one hour.
- 5.5. Charge refrigerant. Keep the refrigerant in liquid state when charging and strictly according to the labeled amount.
- 5.6. Finish the charging, close the valve 2 and screw the seal nut 1 and 3.

# Installation

## 6 Water loop connection

Please pay attention to below matters when the water pipe is connected:

- Try to reduce the resistance to the water from the piping.
- The piping must be clear and free from dirty and blocks. Water leakage test must be carried out to ensure there is no water leaking. And then the insulation can be made.
- Attention that the pipe must be tested by pressure separately. DO NOT test it together with the heat pump.
- There must be expansion tank on the top point of the water loop, and the water level in the tank must be at least 0.5 meter higher than the top point of the water loop.
- The flow switch is installed inside of the heat pump, check to ensure that the wiring and action of the switch is normal and controlled by the controller.
- Try to avoid air stayed inside of the water pipe, and there must be air vent on the top point of the water loop.
- There must be thermometer and pressure meter at the water inlet and outlet, for easy inspection during running.

## 7 Power supply connection

- Open the front panel, and open the power supply access.
- The power supply must go through the wire access and be connected to the power supply terminals in the controlling box. Then connect the 3-signal wire plugs of the wire controller and main controller.
- If the outside water pump is needed, please insert the power supply wire into the wire access also and connect to the water pump terminals.
- If an additional auxiliary heater is need to be controlled by the heat pump controller, the relay (or power) of the aux-heater must be connected to the relevant output of the controller.

## 8 Location of the unit

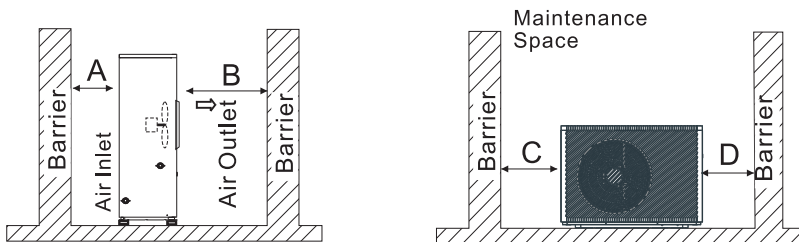

The picture shows the location of horizontal air outlet unit.



### Attention

Requirements

A>500mm ; B>1500mm ;

C>1000mm ; D>500mm

The minimum ventilation distance in diagram 1.

# Installation

## 9 Transit

When the unit need to be hung up during installation, a 8 meters cable is needed, and there must be soft material between the cable and the unit to prevent damage to the heat pump cabinet. (See picture 1)

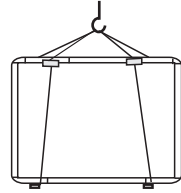

Picture 1



**WARNING**

**DO NOT touch the heat exchanger of the heat pump with fingers or other objects !**

## 10 Trial Running

Inspection before trial running

- Check the indoor unit, and make sure that the pipe connection is right and the relevant valves are open .
- Check the water loop, to ensure that the water inside of the expansion tank is enough, the water supply is good, the water loop is full of water and without any air. Also make sure there is good insulation for the water pipe.
- Check the electrical wiring. Make sure that the power voltage is normal, the screws are fastened, the wiring is made in line with the diagram, and the earthing is connected.
- Check the heat pump unit including all of the screws and parts of the heat pump to see if they are in good order. When power on, review the indicator on the controller to see if there is any failure indication. The gas gauge can be connected to the check valve to see the high pressure(or low pressure) of the system during trial running.

### Trial running

- Start the heat pump by press "🔊" key on the controller. Check whether the water pump is running, if it runs normally there will be 0.2 MPa on the water pressure meter.
- When the water pump runs for 1 minutes, the compressor will start. Hear whether there is strange sound from the compressor. If abnormal sound occurs please stop the unit and check the compressor. If the compressor runs well please look for the pressure meter of the refrigerant.
- Then check whether the power input and running current is in line with the manual. If not please stop and check.
- Adjust the valves on the water loop, to make sure that the hot(cool) water supply to each door is good and meet the requirement of heating(or cooling).
- Review whether the outlet water temperature is stable.
- The parameters of the controller are set by the factory, it is not allowed to change then by user himself.

# Operation and Use

## 1.Main interface display and function



Key	Function
①	Screen lock button: You can perform various operations on the display when the lock is open, but you cannot operate the display when the lock is closed. After locking the screen, press the screen lock button and enter the password “22” to unlock the screen.
④	On/off button: when the button is displayed in blue, it means power on state, and it will turn to white as tapped and switch to power off state.
⑤	Target temperature setting button. When the button is tapped, the unit will enter the target temperature setting interface, allowing you to set the target temperature of the current mode.
⑰	Mode selection button. When the button is tapped, the unit will enter the mode selection interface, allowing you to set the mode. There are five modes : heating, cooling, hot water, hot water + cooling, hot water + heating.

# Operation and Use

---

Icon	Function
②	Main interface icon: It indicates that the current page is the main interface.
③	DHW temperature: The unit is in DHW mode when this icon is shown, otherwise this icon is not shown.
⑥	Inlet temperature: Display the control temperature: Outlet, Room, Buffer Tank, Inlet
⑦	Target temperature: Display the current mode target temperature.
⑧	Fault icon: This icon will be displayed when the unit fails ,then the display will enter Failure record interface after tapping this icon
⑨	Defrosting icon: This icon will be displayed when the unit enters the defrosting function.
⑩	Mute timer icon: This icon will be displayed after the mute timer function is enabled.
⑪	Power on/off timer icon: This icon will be displayed after the power on/off timer function is enabled.
⑫	Mode&temp.&power timer icon: This icon will be displayed when enters this timer
⑬	SG Ready Icon: This icon will be displayed when enters SG Ready, SG Ready includes five modes: Solar Sleep Mode, Solar Low Mode, Solar Medium Mode, Solar High Mode, Normal Mode
⑭	Ambient temperature: Display the current ambient temperature.
⑮	System time: Display the current real-time time. The time can be changed as required.
⑯	Running mode icon: representing the unit is currently running in DHW+heating mode. There are five modes, namely: heating, cooling, hot water, DHW+ cooling, DHW + heating

# Operation and Use

---

## 1.1 On and off

As the main interface shows

- (1) In shutting down interface (on/off key is in white status),  
press on/off key can start up the machine.

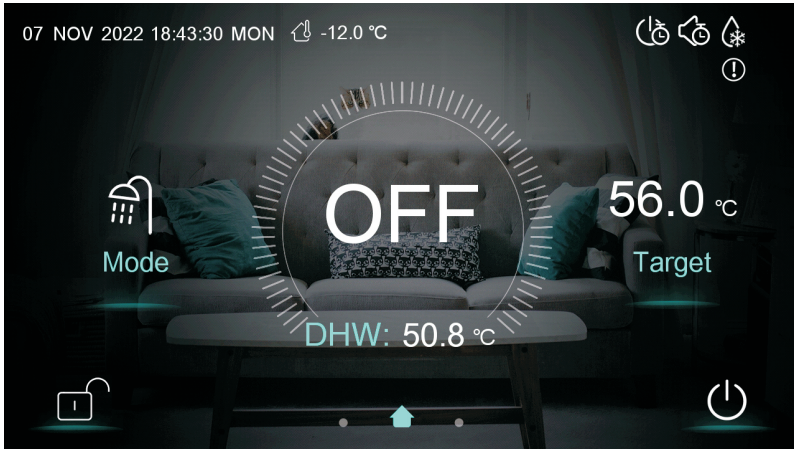

- (2) In starting up interface (on/off key is in blue status),  
press on/off key can shut down the machine.

## 1.2 Mode switch

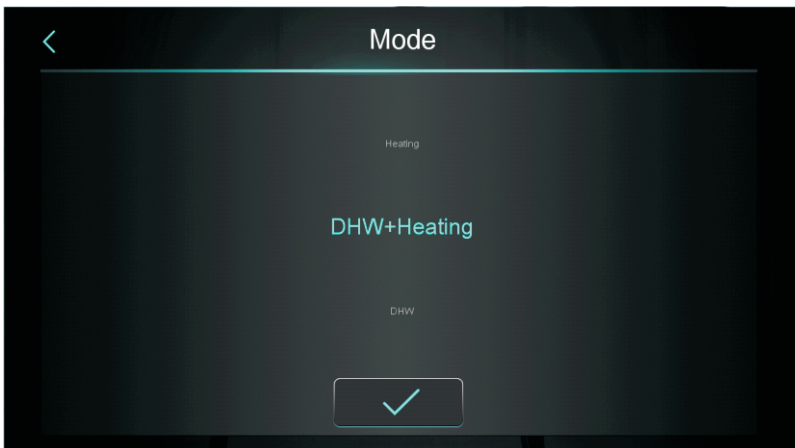



# Operation and Use

There are five modes can be selected after sliding the mode icon.

- (1) selecting DHW mode icon, then the display will change to this mode interface;
- (2) selecting heating mode icon, then the display will change to this mode interface;
- (3) selecting cooling mode icon, then the display will change to this mode interface;
- (4) selecting DHW+heating mode icon, then the display will change to DHW+heating mode interface;
- (5) selecting DHW+cooling mode icon, then the display will change to DHW+cooling mode interface;

Note: a) If the machine model you purchased has no cooling function, the key of cooling mode will not be displayed.

b) If the machine model you purchased has no DHW function, the key of hot water mode function will not be displayed.

c) If the machine model you purchased has only DHW function, the mode interface only displays DHW icon.

## 1.3 Setting of target temperature

### 1.3.1 Disable zone control

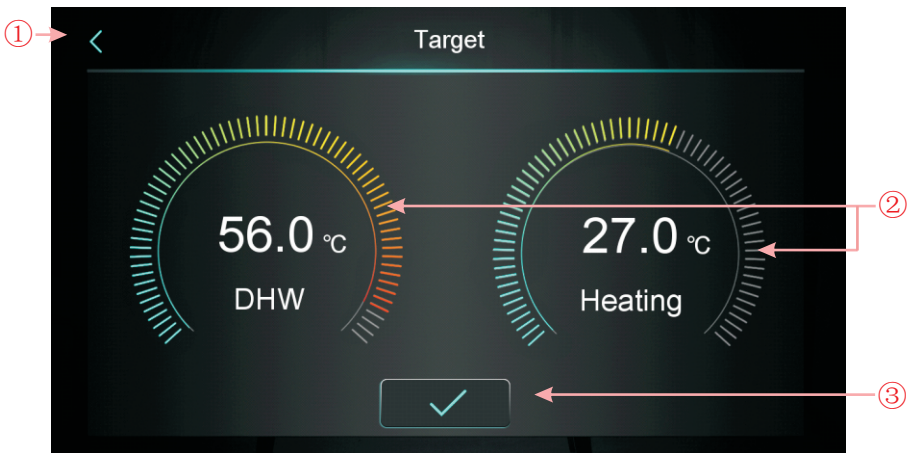

Take DHW + heating mode for example:

- (1) Tapping ①, the wire controller back to the main interface;
- (2) Sliding ②, the target temperature can be adjusted in the clockwise or counterclockwise direction. Minimum adjustment range is 0.5°C.
- (3) Tapping ③, the target temperature can be saved.

Note: When room temperature control, click the room temperature display in the main interface to enter the room target temperature setting page, and slide the adjustment to set the room target temperature.

# Operation and Use

## 1.3.2 Enable zone control

### 1.3.2.1 Heating Mode Multi-Zone Control

When heating or DHW+heating mode, click “” to enter the multi-zone function interface:

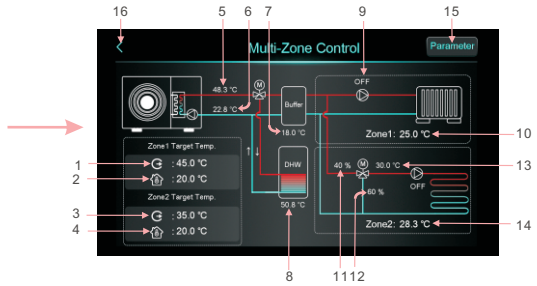
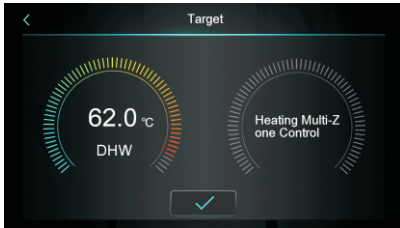

1	Display target outlet temperature in zone 1/target outlet water temperature after compensation
2	Display room target temperature in zone 1, when Z01=4/5/6/7/8/9, it displays “/”
3	Display target outlet temperature in zone 1/target outlet water temperature after compensation
4	Display room target temperature in zone 2, when Z01=4/5/6/7/8/9, it displays “/”
5	Display outlet water temperature
6	Display inlet water temperature
7	When H25=buffer tank control, display buffer tank temperature When H25≠buffer tank control, display --- , and Buffer will become “Not used”
8	Display Tank temperature
9	When zone 1 pump turns on, display “ON”, otherwise display “OFF”
10	Display zone 1 room temperature. When Z01=4/5/6/7/8/9, it means the unit is connected to the passive switch thermostat or room thermostat, and the unit will just receives the signal, when the thermostat asks the unit to turn on, then here will show Zone1: Start, otherwise, it will show Zone1:Stop.
11	Display the percentage of zone 2 mixing valve steps.
12	Display 100 - the percentage of zone 2 mixing valve steps
13	Display zone 2 mixing water temperature
14	Display zone 2 room temperature. When Z01=4/5/6/7/8/9, it means the unit is connected to the passive switch thermostat or room thermostat, and the unit will just receives the signal, when the thermostat asks the unit to turn on, then here will show Zone2: Start, otherwise, it will show Zone2:Stop.
15	After clicking, enter password 22, will enter the multi-zone function parameter list.
16	Click to return the main screen.

# Operation and Use

## 1) Zone 1 target temperature setting interface

Click “ 45.0 °C” to enter the target temperature in zone 1:

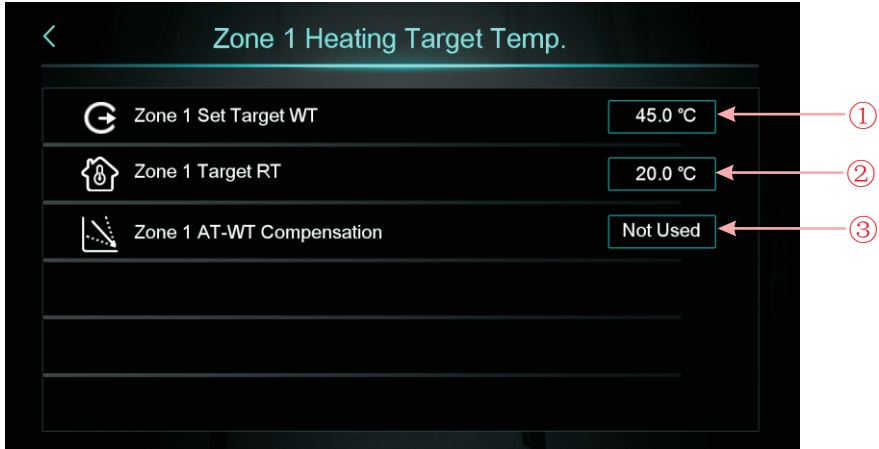

Number	Key name	Key function
①	Zone 1 Set Target WT	Click to set zone 1 target outlet water temperature
②	Zone 1 Target RT	Click to set zone 1 room target temperature, when Z01=4/5/6/7/8/9, it displays “/”
③	Zone 1 AT-WT Compensation	Click to enter the zone 1 weather compensation curve, When the zone 1 weather compensation is disable, it will display Not Used. Enable to display the compensated temperature. Enable condition: Z01=1/3/4/6/7/9 and Z16=1

### Zone 1 weather compensation curve

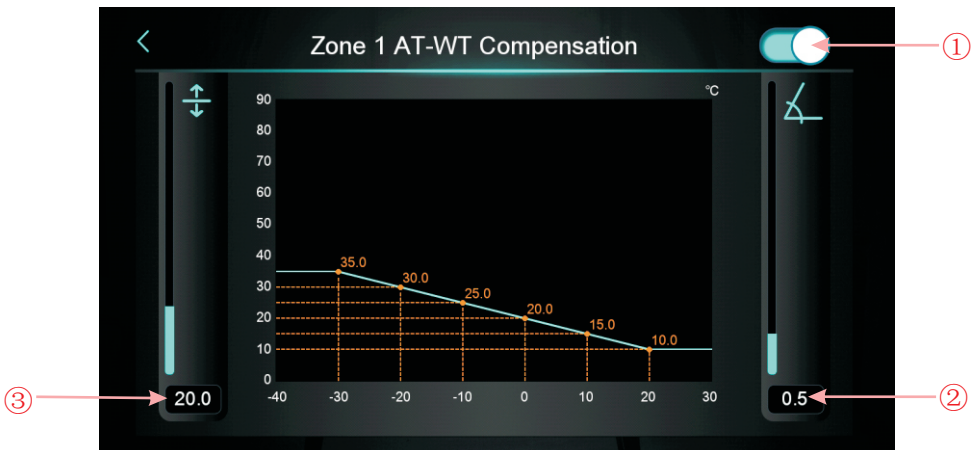

# Operation and Use

Number	Key name	Key function
①	Enable key	Enable weather compensation button.
②	Slope	Set the slope by sliding up and down or clicking on the value
③	Offset	Set the offset by sliding up and down or clicking on the value

Celsius calculation formula: Compensated temp. = -Slope\*Current AT + Offset

Fahrenheit calculation formula: Compensated Target = -Slope\*(Current AT-32)+ Offset

## 2) Zone 2 target temperature setting interface

Click  to enter the target temperature in zone 2:

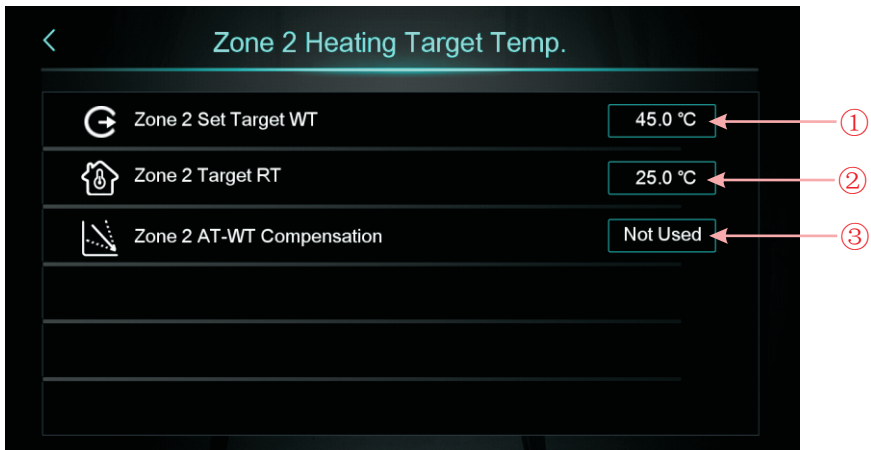

Number	Key name	Key function
①	Zone 2 Set Target WT	Click to set the zone 2 target outlet water temperature
②	Zone 2 Target RT	Click to set the zone 2 room target temperature, when Z01=4/5/6/7/8/9, it displays "I"
③	Zone 2 AT-WT Compensation	Click to enter the zone 2 weather compensation curve, When the zone 2 weather compensation is disable, it will display Not Used. Enable to display the compensated temperature. Enable condition:Z01=2/3/5/6/8/9 and Z17=1

# Operation and Use

## Zone 2 weather compensation curve

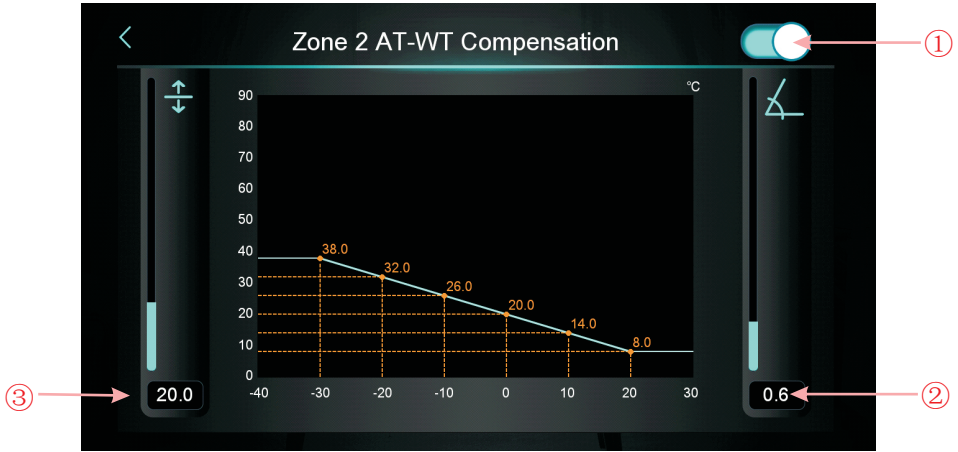

Number	Key name	Key function
①	Enable key	Enable weather compensation button.
②	Slope	Set the slope by sliding up and down or clicking on the value
③	Offset	Set the offset by sliding up and down or clicking on the value

### 3) Zone control function parameters

Click “[Parameter](#)” enter the password 22 to enter the zone control function parameters

# Operation and Use

A: Set Z01 to change the main zone control interface

When Z01=0, it means disable zone 1 and zone 2, display Not Used;

When Z01=2/5/8, it means disable Zone 1, Zone 1 will display Zone 1 Not Used;

When Z01=1/4/7, it means disable Zone 2, Zone 2 will display Zone 2 Not Used;

When Z01=3/6/9, it means enable Zone 1 and Zone 2.

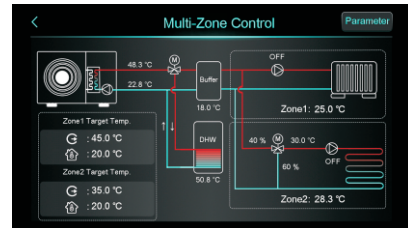
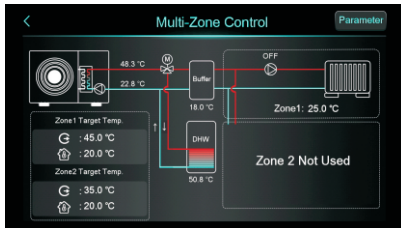
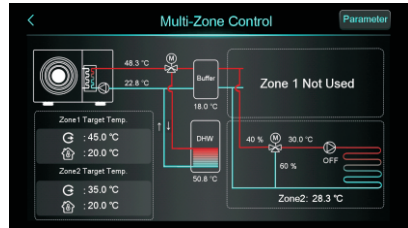
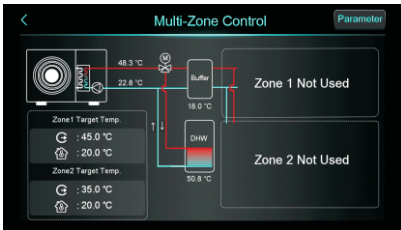

## 1.3.2.2 Cooling Multi-Zone Control

When cooling or DHW+cooling mode, click “ ” to enter the multi-zone function interface:

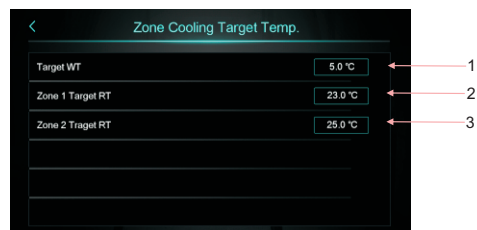

1	Click to set the cooling target temperature
2	Click to set the zone 1 room target temperature
3	Click to set the zone 2 room target temperature

# Operation and Use

## 1.4 Unlock screen

After locking screen, click “

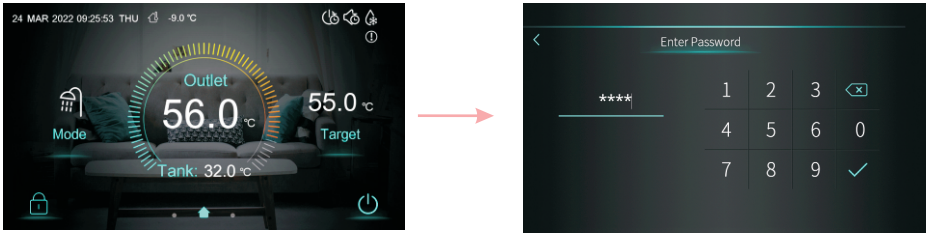

## 2. Setting interface display and function

Swipe from right to left on the main interface to enter the function setting interface, and swipe from left to right on the function setting interface to return to the main interface. The function setting interface is shown in the figure below.

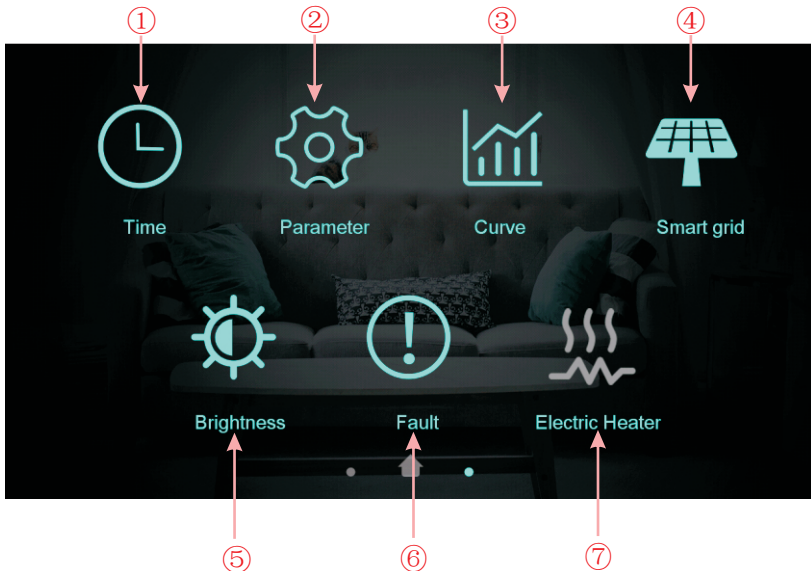



# Operation and Use

## Buttons description

Key number	Key name	Key function
①	Time setting	Click this key to set the time function.
②	Factory parameter	Click the key and enter the password to enter the factory parameter settings and status parameters interface.
③	Curve key	Click this key to view the temperature curve.
④	Smart grid	Click this key to Smart Grid
⑤	Adjust brightness	Click this key to adjust screen brightness
⑥	Fault	Click to view fault history
⑦	Electric Heater	Click to turn on/off the electric heater

### 2.1 Time setting



In the setup interface, tapping the button, then the interface display is shown as follows:

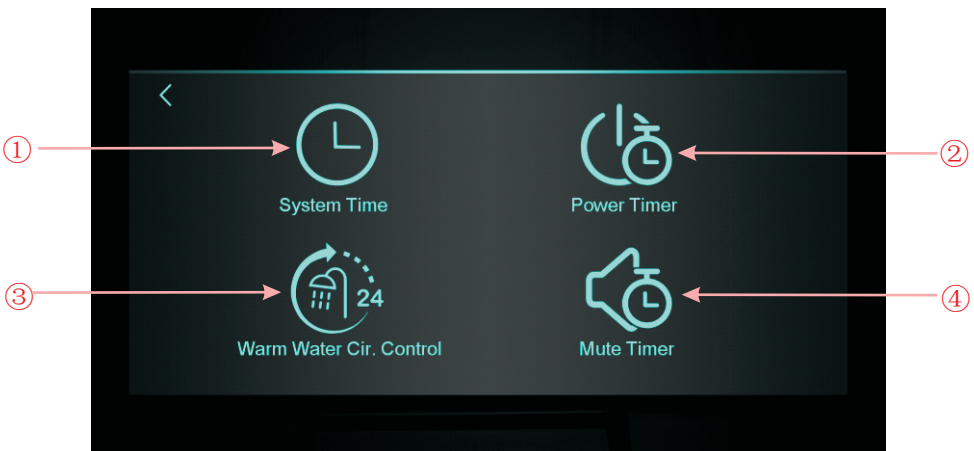



Key number	Key name	Key function
①	System Time	Click to set system time
②	Power Timer	Click to set timed switch on/off
③	Warm Water Cir. Control	Click to set warm water pump timed cycle, hide the icon when H40=0/2, show the icon when H40=1
④	Mute Timer	Click to set timed mute, hide the icon when H22=0, show the icon when H22=1

## 2.1.1 System time setting



In the time setting interface, click ① interface displays as follows:

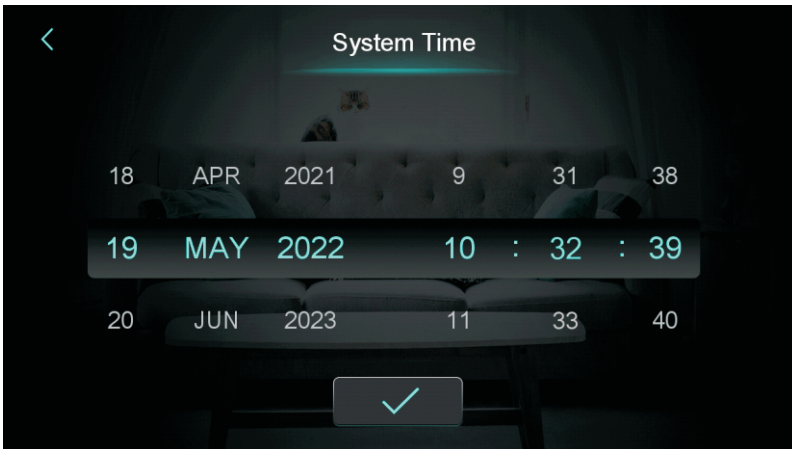

When entering the page of system time setting, the system time will be initialized to the time at the moment when the system time setting button is pressed, and you can adjust the time by sliding up and down.

Note: When the temperature unit is °F, the time format is displayed as: month-day-year hour: minute: second.

# Operation and Use

## 2.1.2 Power Timer setting



In the time setting interface, click ② interface displays as follows:



NO.	Name	Button function
①	Timing switch function on	Clicking the button, when the font color is blue, the timing switch is on
②	Week setting	Set the day of the week to activate the timing switch
③	Time period setting	Set the time to turn on and the time to turn off
④	Turn page	A total of 6 timing switch time periods can be set, which can be selected by turning the page

# Operation and Use

## 2.1.3 Warm Water Cir. Control



In the time setting interface, click ③ interface displays as follows:

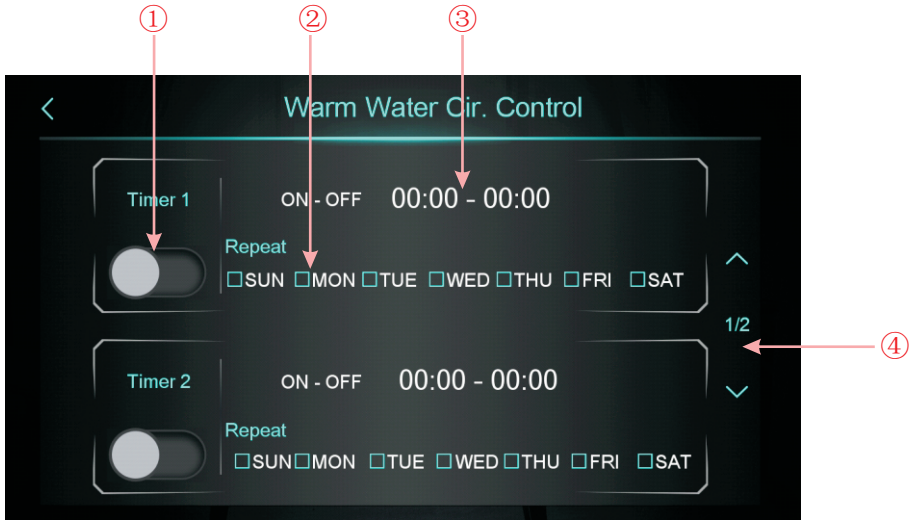

NO.	Name	Button function
①	Timing switch function on	Clicking the button, when the font color is blue, the timing switch is on
②	Week setting	Set the day of the week to activate the timing switch
③	Time period setting	Set the time to turn on and the time to turn off
④	Turn page	A total of 3 timing switch time periods can be set which can be selected by turning the page

# Operation and Use

## 2.1.4 Mute Timer setting



In the time setting interface, click ④ interface displays as follows:



NO.	Name	Key color	Button function
①	Whether enable the mute timer on function	Enable: Blue Disable: Gray	Click this key to enable or disable the mute timer on function
	Whether enable the mute timer off function	Enable: Blue Disable: Gray	Click this key to enable or disable the mute timer off function
②	The mute timer on setting point		select from 0:00-23:59
	The mute timer off setting point		select from 0:00-23:59
③	The status of mute timer on	Enable: Blue Disable: Gray	The status of mute timer on is shown
	The status of mute timer off	Enable: Blue Disable: Gray	The status of mute timer on is shown

# Operation and Use

## 2.2 Temperature Curve



In the setup interface, tapping the button, then the interface display is shown as follows:

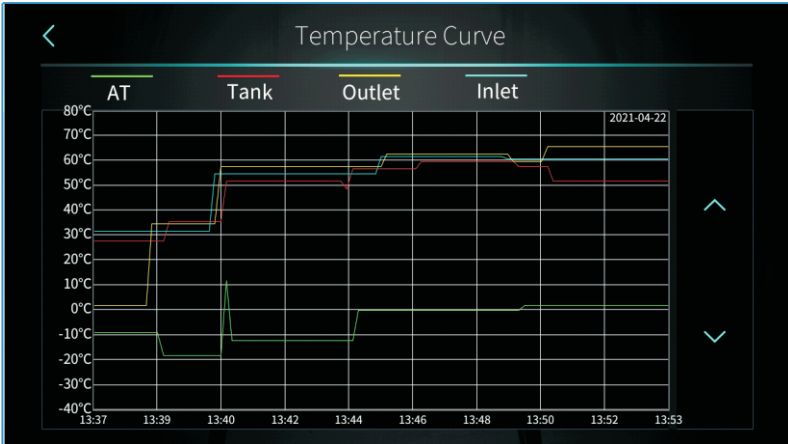

Note:

- 1) This curve function records the water inlet temperature、 water outlet temperature、 tank water temperature and ambient temperature;
- 2) Temperature data is collected and saved every five minutes. Timekeeping is made from the latest data saving, if the power is disrupted when the time is less than five minutes, the data during such period will not be saved;
- 3) Only curve for power-on status is recorded, and that for power-off will not be saved;
- 4) The value of the abscissa indicates the time from the point on the curve to the current time point. The rightmost point on the first page is the latest temperature record;
- 5) Temperature curve record is provided with power-down memory function.

## 2.3 Smart Grid



In the setup interface, tapping the button, then the interface display is shown as follows:



Key number	Key name	Key function
①	SG Ready	Click to enter SG Ready
②	Mode&Temp.&Power Timer	Click to enter Mode&Temp.&Power Timer

### 2.3.1 SG Ready Function



#### 2.3.1.1 Disable SG Ready

When the Smart Grid Ready mode is not yet set, the interface will display:

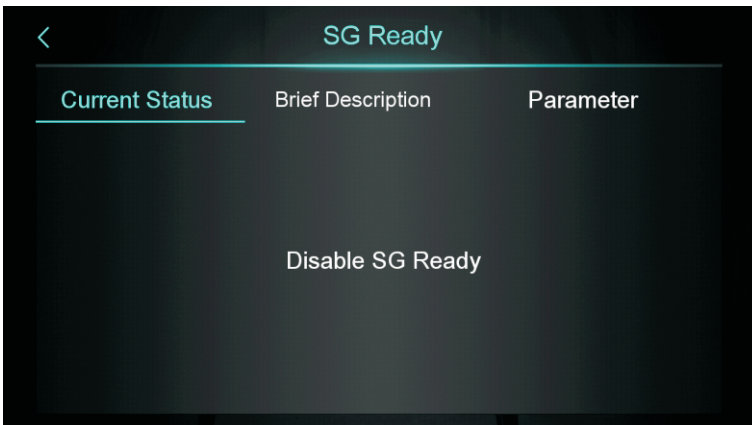

# Operation and Use

## 2.3.1.2 Smart Grid Ready=1

When using one dry contact, the interface will display:

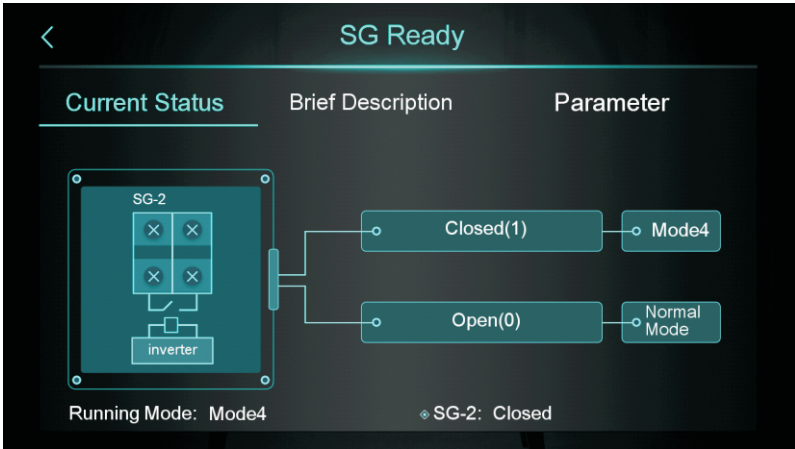

Click "Brief Description" to enter the function description screen:

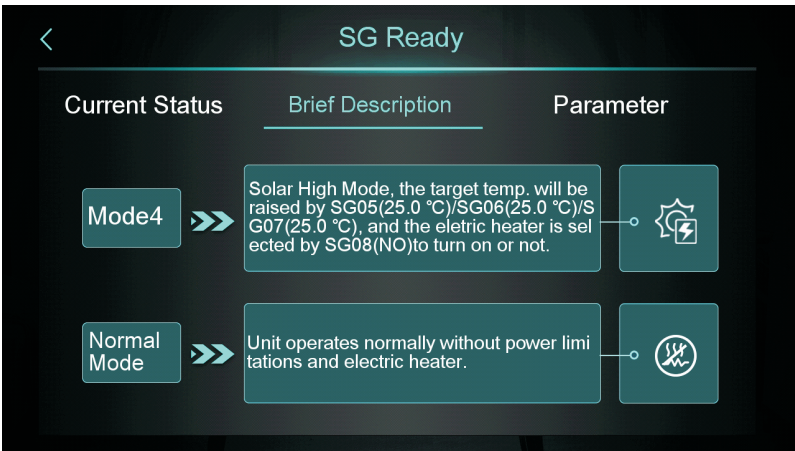



# Operation and Use

Click "Parameter" and enter the password "22" to enter the parameter setting screen:



## 2.3.1.2 Smart Grid Ready=2

When using two dry contacts, the interface will display:

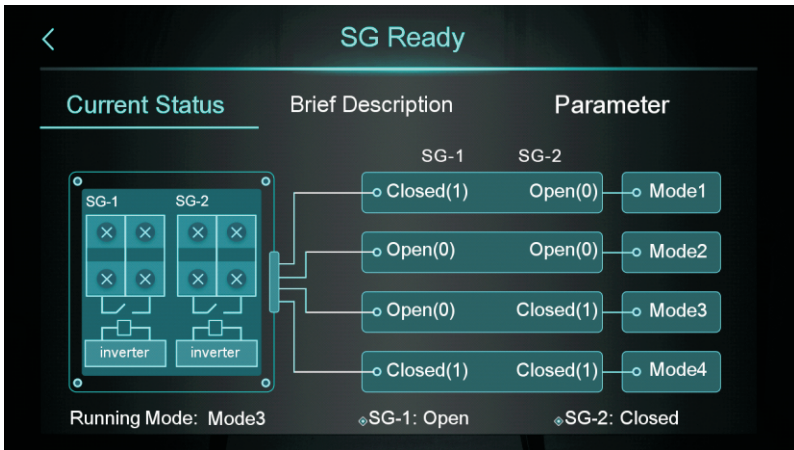



# Operation and Use

Click "Brief Description" to enter the function description screen:

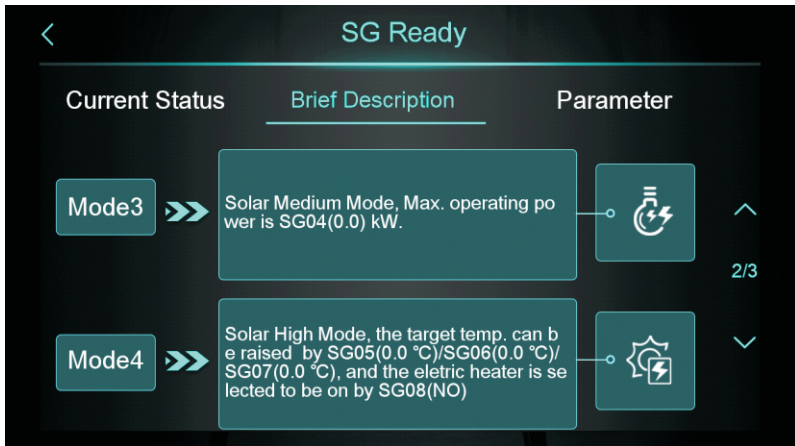

Click "Parameter" and enter the password "22" to enter the parameter setting screen:



# Operation and Use

## 2.3.2 Mode&Temp.&Power Timer



Click “” to enter the Mode&Temp.&Power Timer screen:

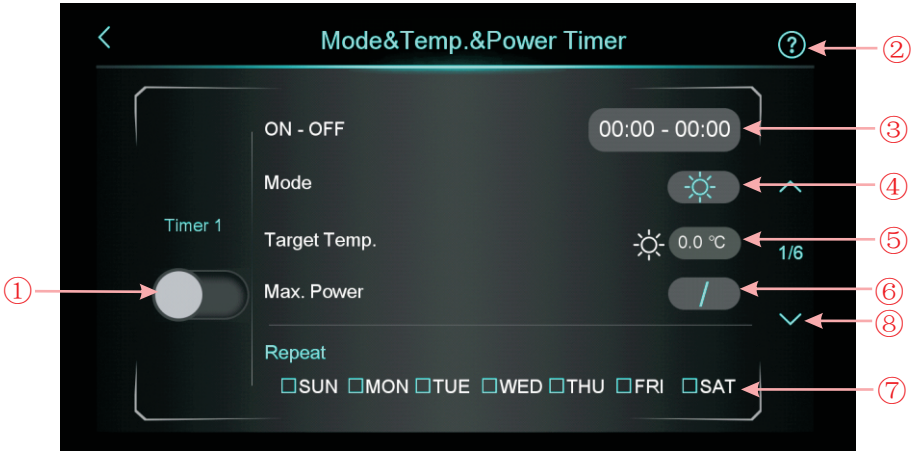

NO.	Name	Button function
①	Enable key	Enable the timer,when the font color is blue, the timing switch is on
②	Function Description	Click to enter the function introduction
③	Time setting	Set timer time
④	Mode	Set target mode, If you don't need to control mode, please choose “/”
⑤	Target Temp.	Set target temperature
⑥	Max. Power	Set power limitation, Setting range 0.0~99.9KW. If you don't need to limite the power, please set “Max. Power” to 0.
⑦	Week setting	Set timer date
⑧	Turn page	A total of 6 timing switch time periods can be set, which can be selected by turning the page

# Operation and Use

---

## 2.4 Color Display Calibration



In the setup interface, tapping the button, then the interface display is shown as follows:

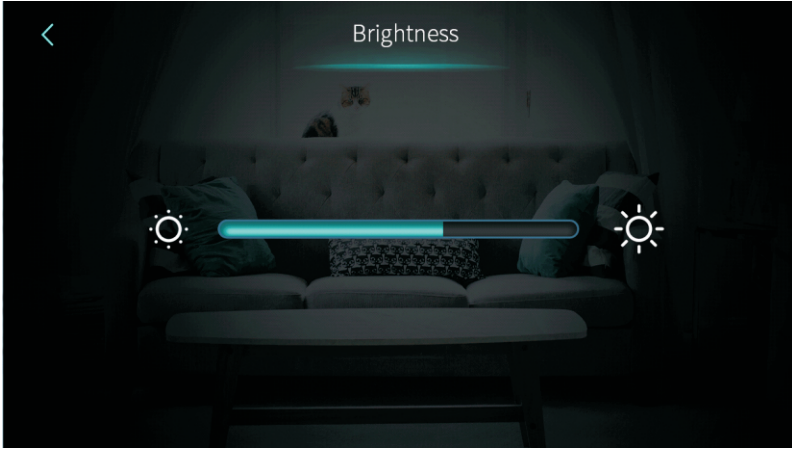

Note:

- 1) The middle display bar can be dragged or clicked to adjust the brightness of the screen, with power-down memory.
- 2) Press the back key to return to the previous level and save the brightness setting value.
- 3) The screen has the function of automatic on and off, if there is no operation for 30s, the screen will enter the half-time screen state.
- 4) If there is no operation for another 5 minutes, the screen will enter the screen state.

# Operation and Use

## 2.5.Fault interface display and function



In the setup interface, tapping the button, then the interface display is shown as follows:

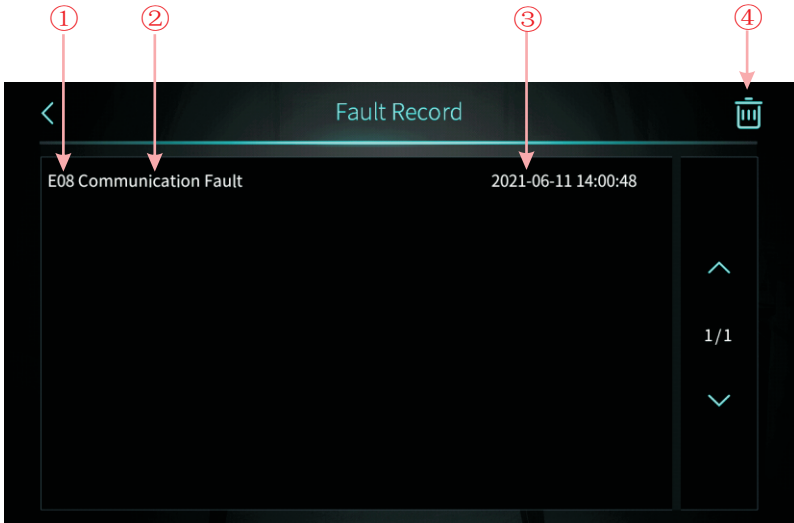

①:Fault code ②:Fault name

③:Occurrence time of the fault: Day and month hour:minute:second

Note:If the current temperature is °F, occurrence time of the fault:

Month and day hour: minute: second

④:Click this key to clear all fault records, enter the date of the day into the OK screen.

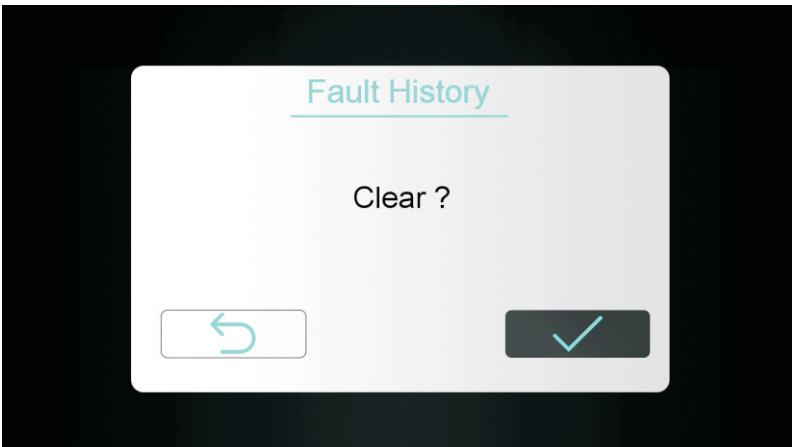

## 2.6 Electric Heater



In the setup interface, tapping the button, One-click to turn electric heater on or off. On is bright, off is grey.

Note: When electric heating is not enabled, the icon is hidden.

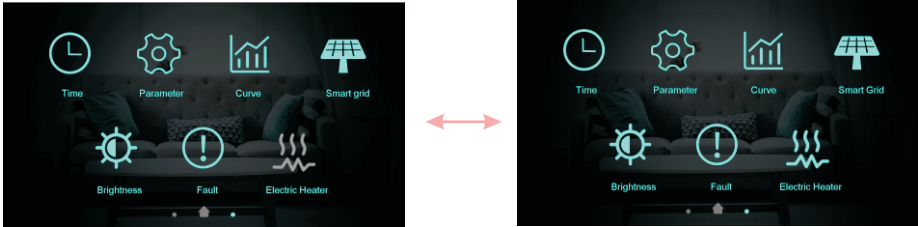

## 3. Status interface display

Swipe from left to right on the main screen to enter the main status screen. Swipe from right to left on the main status screen to return to the main screen interface. The main status screen displays the main status parameters.

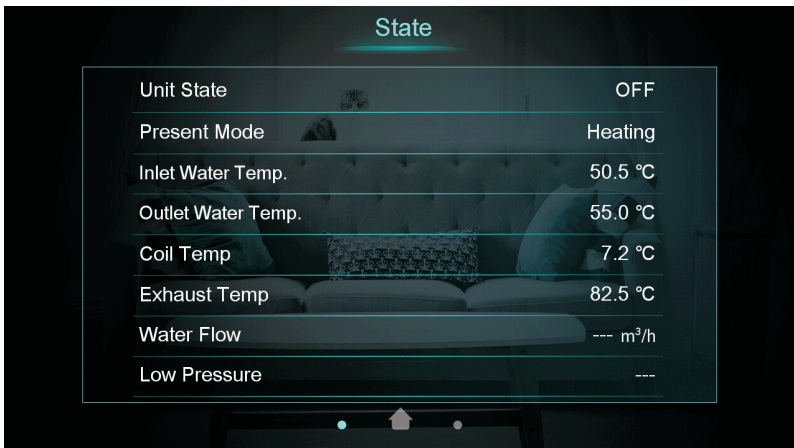

# Operation and Use

## 4. Parameter list and breakdown table

### 4.1 Electronic control fault table

Can be judged according to the remote controller failure code and troubleshooting.

Protect/fault	Fault display	Reason	Elimination methods
Inlet Water Temp. Sensor Fault	P01	The temp. sensor is broken or short circuit	Check or change the temp. sensor
Outlet Water Temp. Sensor Fault	P02	The temp. sensor is broken or short circuit	Check or change the temp. sensor
DHW Tank Sensor Fault	P03	The temp. sensor is broken or short circuit	Check or change the temp. sensor
AT Sensor Fault	P04	The temp. sensor is broken or short circuit	Check or change the temp. sensor
Suction Temp. Sensor Fault	P17	The temp. sensor is broken or short circuit	Check or change the temp. sensor
Heating Returning Water Temp. Sensor Fault	P013	The temp. sensor is broken or short circuit	Check or change the temp. sensor
DHW Returning Water Temp. Sensor Fault	P018	The temp. sensor is broken or short circuit	Check or change the temp. sensor
Heating Leaving Water Temp. Sensor Fault	P023	The temp. sensor is broken or short circuit	Check or change the temp. sensor
DHW Leaving Water Temp. Sensor Fault	P028	The temp. sensor is broken or short circuit	Check or change the temp. sensor
Room Temp. Sensor Fault	P42	The temp. sensor is broken or short circuit	Check or change the temp. sensor
EVI Inlet Sensor Fault	P101	The temp. sensor is broken or short circuit	Check or change the temp. sensor
EVI Outlet Sensor Fault	P102	The temp. sensor is broken or short circuit	Check or change the temp. sensor
Distributor Tube Temp. Sensor Fault	P152	The temp. sensor is broken or short circuit	Check or change the temp. sensor
Coil Temp. Sensor Fault	P153	The temp. sensor is broken or short circuit	Check or change the temp. sensor
Exhaust Temp. Sensor Fault	P181	The temp. sensor is broken or short circuit	Check or change the temp. sensor
Overhigh Exhaust Temp.	P182	The compressor is overload	Check whether the system of the compressor running normally
Anti-freezing Temp. Sensor Fault	P191	The temp. sensor is broken or short circuit	Check or change the temp. sensor
Mix Tube Outlet Water Temp. Sensor Fault	P02a	The temp. sensor is broken or short circuit	Check or change the temp. sensor
Buffer Tank Temp. Sensor Fault	P03a	The sensor is broken or short circuit	Check or change the temp. sensor
Pressure Sensor Fault	PP11	The pressure sensor is broken or short circuit	Check or change the pressure sensor or pressure
High Pressure Sensor Fault	PP12	The pressure sensor is broken or short circuit	Check or change the pressure sensor or pressure
Low AT Protection	TP	The ambient temp. is low	Check the ambient temp value
No Cooling at Low AT Protection	TC	The temp. sensor is incorrectly-detected or the temp.sensor is lower-than the set value A30	Check or change the temp. sensor
Electric Heater Overheat Fault	E04	The electric-heater protection switch is broken	Check whether the electric heater runs at the temperature above 150°C for a long time
Excess Temp. Diff. Between Inlet & outlet	E06	Water flow is not enough and low differential pressure	Check the pipe water flow and whether water system is jammed or not
Communication Fault	E08	Communication failure between wire controller and mainboard	Check the wire connection between remote wire controller and main board

# Operation and Use

Protect/fault	Fault display	Reason	Elimination methods
Primary Anti-freezing Fault	E19	The ambient temp. is low	Check the ambient temp value
Secondary Anti-freezing Fault	E29	The ambient temp. is low	Check the ambient temp value
Insufficient Defrosting Water Flow Alarm	E030	The unit flow rate is less than the minimum flow value of the unit.	Check or change waterway systems to provide unit flow
Flow Switch Fault	E032	No water/little water in water system	Check the pipe water flow and water pump
Overhigh Outlet Water Temp.	E065	No water/little water in water system	Check the pipe water flow and water pump
Low Outlet Water Temp. Temp. Fault	E071	No water/little water in water system	Check the pipe water flow and water pump
Fan Motor 1 and PCB Communication Fault	E081	Speed control module and main board communication fail	Check the communication connection
Fan Motor 2 and PCB Communication Fault	E082	Speed control module and main board communication fail	Check the communication connection
Display and PCB Communication Fault	E084	The wire controller software is not match the mainboard software	Check the wire control software number and the mainboard software number
Communication Fault with Hydraulic Module	E08c	Hydraulic Module and mainboard communication fail	Check the communication connection
HP Fault	E11	The high-pressure switch is broken	Check the pressure switch and cold circuit
LP Fault	E12	The low-pressure switch is broken	Check the pressure switch and cold circuit
Anti-freezing Fault	E171	Use side water system temp. is low	1. Check the water temp. or change the temp. sensor 2. Check the pipe water flow and whether water system is jammed or not
Fan Motor1 Fault	F031	1. Motor is in locked-rotor state 2. The wire connection between DC-fan motor module and fan motor is in bad contact	1. Change a new fan motor 2. Check the wire connection and make sure they are in good contact
Fan Motor2 Fault	F032	1. Motor is in locked-rotor state 2. The wire connection between DC-fan motor module and fan motor is in bad contact	1. Change a new fan motor 2. Check the wire connection and make sure they are in good contact
Zone 1 Room Temp. Sensor Fault	P105	The temp. sensor is broken or short circuit	Check or change the temp. sensor
Zone 2 Room Temp. Sensor Fault	P106	The temp. sensor is broken or short circuit	Check or change the temp. sensor
Zone 2 Mixing Temp. Sensor Fault	P107	The temp. sensor is broken or short circuit	Check or change the temp. sensor
Abnormal Adjustment of Mixing Valve	E122	1. Mixing Valve is incorrectly connected; 2. Mixing Valve is damaged;	1. Plug and unplug terminals; 1. Replace the Mixing Valve;
Zone 1 Thermostat Communication Fault	E08g	1. Thermostat not connected 2. Thermostat failure 3. Wrong parameter setting	1. Check the wiring connection between the thermostat and the unit 2. Replace the thermostat 3. Check the parameters
Zone 2 Thermostat Communication Fault	E08h	1. Thermostat not connected 2. Thermostat failure 3. Wrong parameter setting	1. Check the wiring connection between the thermostat and the unit 2. Replace the thermostat 3. Check the parameters
Low Water Flow Protection	E035	Water flow is too low	Increased water flow

# Operation and Use

Frequency conversion board fault table:

Protect/fault	Fault display	Reason	Elimination methods
IPM Overcurrent Fault	F00	IPM Input current is large	Check and adjust the current measurement
Comp. Driver Fault	F01	Lack of phase, step or drive hardware damage	Check the measuring voltage check frequency conversion board hardware
Pre-Charge Failure	F03	The PFC circuit protection	Check the PFC switch tube short circuit or not
DC Power Bus Overvoltage Fault	F05	DC bus voltage>Dc bus Overload-voltage protection value	Check the input voltage measurement
DC Power Bus Undervoltage	F06	DC bus voltage<Dc bus Underload-voltage protection value	Check the input voltage measurement
AC Power Undervoltage Fault	F07	The input voltage is low, causing the input current is low	Check the input voltage measurement
AC Power Overcurrent Fault	F08	The input voltage is too high, more than outage protection current RMS	Check the input voltage measurement
Input Power Voltage Sampling Fault	F09	The input voltage sampling fault	Check and adjust the current measurement
DSP and PFC Communication Fault	F12	DSP and PFC connect fault	Check the communication connection
DSP and Comp. Driver Communication Fault	F11	DSP and Inverter board communication failure	Check the communication connection
Comp. Driver and PCB Communication Fault	F151	DSP and Mainboard communication failure	Check the communication connection
IPM Overheat Fault	F13	The IPM module is overheat	Check and adjust the current measurement
Comp. Overcurrent Fault	E051	The compressor is overload	Check whether the system of the compressor running normally
Input Power Lacking Phase Fault	F15	The input voltage lost phase	Check and measure the voltage adjustment
IPM Current Sampling Fault	F18	IPM sampling electricity is fault	Check and adjust the current measurement
Comp. Driver Temp. Sensor Fault	F17	The transducer is overheat	Check and adjust the current measurement
IGBT Power Device Overheat Alarm	F20	The IGBT is overheat	Check and adjust the current measurement
Comp. Weak Magnetic Alarm	F16	Compressor magnetic force is not enough	Check and adjust the current measurement
AC Input Current Frequency Decrease Alarm	F22	Input current is too large	Check and adjust the current measurement
EEPROM Alarm	F23	MCU error	Check whether the chip is damaged Replace the chip
Destroyed EEPROM & No Activated Fault	F24	MCU error	Check whether the chip is damaged Replace the chip
Input Power Current Sampling Fault	F25	The V15V is overload or undervoltage	Check the V15V input voltage in range 13.5V~16.5V or not
IGBT Overheat Fault	F26	The IGBT is overheat	Check and adjust the current measurement
Comp. Current Frequency Decrease Alarm	F33	The compressor current frequency reduction	Check and adjust the current measurement
AC Power Overvoltage Fault	F10	Input voltage>Input Overload-voltage protection value	Check whether the input voltage is higher than 265V
Compressor Lacking Phase Fault	F14	The compressor lost phase	Check whether compressor cables are connected properly and reliably
EEPROM Fault	F29	Failed to read the memory chip	Check the frequency conversion board
Overspeed Fault	F21	The compressor is running abnormally	Check whether the compressor cable is normal and whether the compressor is blocked



# Operation and Use

Protect/fault	Fault display	Reason	Elimination methods
Driver (Fan)Temp.Sensor Fault	F120	The temp. sensor is broken or short circuit	Check or change the temp. sensor
Driver (Fan)IPM Overheat Fault	F106	The fan IPM drive plate has poor heat dissipation	Check heat dissipation conditions
Driver (Fan) External Overcurrent Fault	F105	The fan IPM hardware running current is too large	Check whether the fan is blocked
Driver (Fan) Power Lacking Phase Fault	F101	The fan lost phase	Check whether fan cables are connected properly and reliably
Driver (Fan) Current Sampling Fault	F112	Fan sampling electricity is fault	Check whether the fan drive plate is abnormal
Driver (Fan) Start Fault	F102	The fan fails to start	Check whether the fan is blocked
Driver (Fan) Internal Overcurrent Fault	F113	The fan software running current is too large	Check whether the fan is blocked
Driver (Fan) overspeed Fault	F109	The fan speed is too high	Check whether the fan drive board is abnormal

## 4.2 Parameter list

Meaning	Default	Remarks
Cooling target temperature set point	12℃	Adjustable
Heating the target temperature set point	45℃	Adjustable
Hot water target temperature set point	55℃	Adjustable

## 5. Interface diagram

### 5.1 Wire control interface diagram and definition

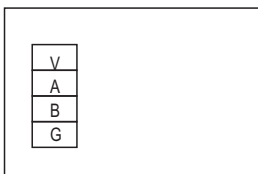

Sign	Meaning
V	12V (power +)
A	485A
B	485B
G	GND(power-)

# Operation and Use

## 5.2 Controller interface diagram and definition

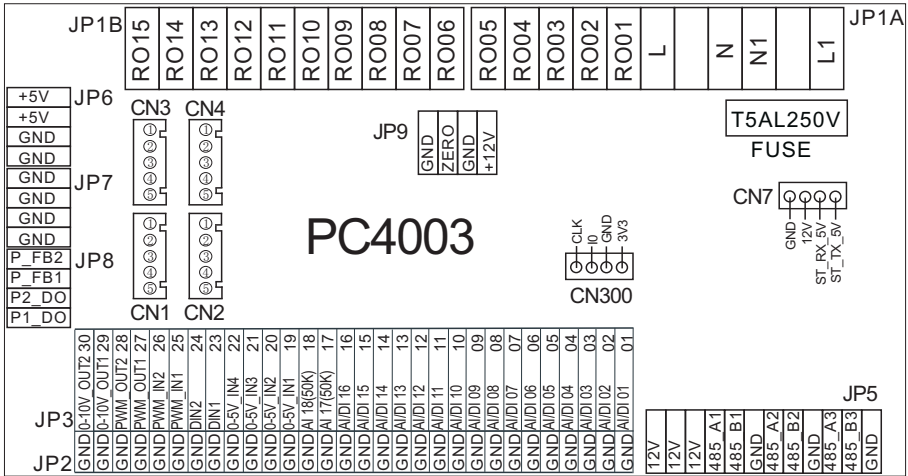

# Operation and Use

Main board of the input and output interface instructions below

Number	Sign	Meaning
01	AI/DI01	Inlet Water Temp.
02	AI/DI02	Outlet Water Temp.
03	AI/DI03	Coil Temp.
04	AI/DI04	Ambient Temp. (AT)
05	AI/DI05	Suction Temp.
06	AI/DI06	Antifreeze Temp.
07	AI/DI07	Zone 1 room temp./Zone 1-P
08	AI/DI08	DHW Tank Temp.
09	AI/DI09	Room Temp. /Buffer Tank Temp.
10	AI/DI10	EVI Inlet Temp.
11	AI/DI11	EVI Outlet Temp.
12	AI/DI12	High Pressure Switch
13	AI/DI13	Low Pressure Switch
14	AI/DI14	Flow Switch
15	AI/DI15	Zone 2 Water Temp. after Mixing
16	AI/DI16	Remote Switch/SG-1
17	AI/17 (50k)	DHW Switch/Zone 2 room temp./Zone 2-P
18	AI/18 (50K)	Exhaust Temp.
19	0~5V_IN1	Transformer Current 1
20	0~5V_IN2	Transformer Current 2
21	0~5V_IN3	Transformer Current 3
22	0~5V_IN4	Low Pressure
23	DIN_1	Heating & Cooling Function Switch
24	DIN_2	Heating / Cooling Mode Switch
25	PWM_IN1	Water Flow Rate
26	PWM_IN2	Reserved
27	PWM_OUT1	Heating & Cooling Function Switch Output
28	PWM_OUT2	Heating / Cooling Mode Switch Output
29	0~10V_OUT1	Mixing valve output
30	0~10V_OUT2	Reserved
31	+5V	5V output
32	+12V	12V output
33	CN1	EEV Steps
34	CN2	EVI EEV Steps
35	CN3	Reserved
36	CN4	Reserved
37	CN300	Program port
38	JP5_1	5 inch color display/DC fan speed regulation module/ Frequency conversion board/Hydraulic module
39	JP5_2	Centralized control communication port
40	JP5_3	DTU/WIFI/Thermostat 1/Thermostat 2
41	RO01	Compressor

# Operation and Use

---

42	RO02	Zone 2 Mixing valve Open
43	RO03	Zone 2 Mixing valve Closed
44	RO04	Main Circulation Pump
45	RO05	DHW Pump
46	RO06	4-way valve
47	RO07	Electric Heater Stage 1
48	RO08	Electric Heater Stage 2
49	RO09	Hot water 3-way valve
50	RO10	Crankcase Heater
51	RO11	Bottom Plate Heater
52	RO12	Cooling 3-Way Valve
53	RO13	DHW Electric Heater
54	RO14	Zone 1 pump
55	RO15	Zone 2 pump
56	JP9	12V input
57	CN7	Reserved
58	P_FB2	Reserved
59	P_FB1	Reserved
60	P2_DO	Reserved
61	P1_DO	Reserved

**Note:**

JP5\_1 represents +12V, 485\_A1, 485\_B1, GND on the JP5 terminal;  
JP5\_2 represents +12V, 485\_A2, 485\_B2, GND on the JP5 terminal;  
JP5\_3 represents +12V, 485\_A3, 485\_B3, GND on the JP5 terminal.

## Appendix 1、 Caution & Warning

1. The unit can only be repaired by qualified installer centre personnel or an authorised dealer. (for Europe market)
2. This appliance is not intended for use by persons (including children) with reduced physical sensory or mental capabilities, or lack of experience and knowledge, unless they have been given supervision or instruction concerning use of the appliance by a person responsible for their safety. (for Europe market)  
Children should be supervised to ensure that they do not play with the appliance.
3. Please make sure that the unit and power connection have good earthing, otherwise may cause electrical shock.
4. If the supply cord is damaged, it must be replaced by the manufacturer or our service agent or similarly qualified person in order to avoid a hazard.
5. Directive 2002/96/EC (WEEE):  
The symbol depicting a crossed-out waste bin that is underneath the appliance indicates that this product, at the end of its useful life, must be handled separately from domestic waste, must be taken to a recycling centre for electric and electronic devices or handed back to the dealer when purchasing an equivalent appliance.
6. Directive 2002/95/EC (RoHS): This product is compliant with directive 2002/95/EC (RoHS) concerning restrictions for the use of harmful substances in electric and electronic devices.
7. The unit CANNOT be installed near the flammable gas. Once there is any leakage of the gas, fire can occur.
8. Make sure that there is circuit breaker for the unit, lack of circuit breaker can lead to electrical shock or fire.
9. The heat pump located inside the unit is equipped with an over-load protection system. It does not allow for the unit to start for at least 3 minutes from a previous stoppage.
10. The unit can only be repaired by the qualified personnel of an installer center or an authorized dealer. (for North America market)
11. Installation must be performed in accordance with the NEC/CEC by authorized person only. (for North America market)
12. USE SUPPLY WIRES SUITABLE FOR 75°C.
13. Caution: Single wall heat exchanger, not suitable for potable water connection.

# Appendix

## Appendix 2、Cable specification

### 1. Single phase unit

Nameplate maximum current	Phase line	Earth line	MCB	Creepage protector	Signal line
No more than 10A	2×1.5mm <sup>2</sup>	1.5mm <sup>2</sup>	20A	30mA less than 0.1 sec	n×0.5mm <sup>2</sup>
10~16A	2×2.5mm <sup>2</sup>	2.5mm <sup>2</sup>	32A	30mA less than 0.1 sec	
16~25A	2×4mm <sup>2</sup>	4mm <sup>2</sup>	40A	30mA less than 0.1 sec	
25~32A	2×6mm <sup>2</sup>	6mm <sup>2</sup>	40A	30mA less than 0.1 sec	
32~40A	2×10mm <sup>2</sup>	10mm <sup>2</sup>	63A	30mA less than 0.1 sec	
40~63A	2×16mm <sup>2</sup>	16mm <sup>2</sup>	80A	30mA less than 0.1 sec	
63~75A	2×25mm <sup>2</sup>	25mm <sup>2</sup>	100A	30mA less than 0.1 sec	
75~101A	2×25mm <sup>2</sup>	25mm <sup>2</sup>	125A	30mA less than 0.1 sec	
101~123A	2×35mm <sup>2</sup>	35mm <sup>2</sup>	160A	30mA less than 0.1 sec	
123~148A	2×50mm <sup>2</sup>	50mm <sup>2</sup>	225A	30mA less than 0.1 sec	
148~186A	2×70mm <sup>2</sup>	70mm <sup>2</sup>	250A	30mA less than 0.1 sec	
186~224A	2×95mm <sup>2</sup>	95mm <sup>2</sup>	280A	30mA less than 0.1 sec	

### 2. Three phase unit

Nameplate maximum current	Phase line	Earth line	MCB	Creepage protector	Signal line
No more than 10A	3×1.5mm <sup>2</sup>	1.5mm <sup>2</sup>	20A	30mA less than 0.1 sec	n×0.5mm <sup>2</sup>
10~16A	3×2.5mm <sup>2</sup>	2.5mm <sup>2</sup>	32A	30mA less than 0.1 sec	
16~25A	3×4mm <sup>2</sup>	4mm <sup>2</sup>	40A	30mA less than 0.1 sec	
25~32A	3×6mm <sup>2</sup>	6mm <sup>2</sup>	40A	30mA less than 0.1 sec	
32~40A	3×10mm <sup>2</sup>	10mm <sup>2</sup>	63A	30mA less than 0.1 sec	
40~63A	3×16mm <sup>2</sup>	16mm <sup>2</sup>	80A	30mA less than 0.1 sec	
63~75A	3×25mm <sup>2</sup>	25mm <sup>2</sup>	100A	30mA less than 0.1 sec	
75~101A	3×25mm <sup>2</sup>	25mm <sup>2</sup>	125A	30mA less than 0.1 sec	
101~123A	3×35mm <sup>2</sup>	35mm <sup>2</sup>	160A	30mA less than 0.1 sec	
123~148A	3×50mm <sup>2</sup>	50mm <sup>2</sup>	225A	30mA less than 0.1 sec	
148~186A	3×70mm <sup>2</sup>	70mm <sup>2</sup>	250A	30mA less than 0.1 sec	
186~224A	3×95mm <sup>2</sup>	95mm <sup>2</sup>	280A	30mA less than 0.1 sec	

When the unit will be installed at outdoor, please use the cable which can against UV.

# Appendix

## Appendix 3\ Water quality requirements

### 1. Corrosi resistance of stainless steel and brazed materials in tap water at room temperature

Attention: + : Good corrosion resistance under normal conditions  
 0 : There may be corrosion problems  
 - : Not recommended

			Plate material			Brazing material		
Moisture	Concentration	Time limit	AISI 304	AISI 316	254 SMO	Cuprum	Nickel	SS
Alkalinity (HCO <sub>3</sub> <sup>-</sup> )	<70	24h	+	+	+	0	+	+
	70-300		+	+	+	+	+	+
	>300		+	+	+	0/+	+	+
Sulfate (SO <sub>4</sub> <sup>2-</sup> )	<70	unlimited	+	+	+	+	+	+
	70-300		+	+	+	0/-	+	+
	>300		+	+	+	-	+	+
HCO <sub>3</sub> <sup>-</sup> /SO <sub>4</sub> <sup>2-</sup>	>1.0	unlimited	+	+	+	+	+	+
	<1.0		+	+	+	0/-	+	+
Electrical conductivity	<10	unlimited	+	+	+	0	+	+
	10-500		+	+	+	+	+	+
	>500		+	+	+	0	+	+
pH	<6.0	24h	0	0	0	0	+	0
	6.0-7.5		+	+	+	0	+	+
	7.5-9		+	+	+	+	+	+
	>9		+	+	+	+	+	+
			+	+	+	+	0	+
Ammonium (NH <sub>4</sub> <sup>+</sup> )	<2	24h	+	+	+	+	+	+
	2-20		+	+	+	0	+	+
	>20		+	+	+	-	+	+
Chloride (Cl <sup>-</sup> )	<10	unlimited	+	+	+	+	+	+
	100-200		0	+	+	+	+	+
	200-300		-	+	+	+	+	+
	>300		-	-	+	+	+	+
			-	-	+	+	0/+	+

Note: \_\_\_\_\_

\_\_\_\_\_

\_\_\_\_\_

\_\_\_\_\_

\_\_\_\_\_

\_\_\_\_\_

\_\_\_\_\_

\_\_\_\_\_

\_\_\_\_\_

\_\_\_\_\_

\_\_\_\_\_

\_\_\_\_\_

\_\_\_\_\_

\_\_\_\_\_

\_\_\_\_\_

\_\_\_\_\_

\_\_\_\_\_

\_\_\_\_\_

\_\_\_\_\_

\_\_\_\_\_

\_\_\_\_\_





